

WORKHORSE PRODUCTS

PRECISION SCREEN PRINTING EQUIPMENT



WORKHORSE PRODUCTS

SCREEN PRINTING EQUIPMENT BUILT FOR THE FUTURE



WORKHORSE HAS BEEN A DOMINANT PLAYER IN THE TEXTILE DECORATING INDUSTRY FOR DECADES BECAUSE WE'RE COMMITTED TO OUR CUSTOMERS' SUCCESS. THIS IS MADE EVIDENT BY OUR DURABILITY IN PRODUCT DESIGN, SOFTWARE WITH AUTO-UPDATING FEATURES TO GIVE YOU THE LATEST FUNCTIONALITY, AND OUR TOP-RATED TECHNICAL SERVICES DEPARTMENT.

Lawrence, shown in our Phoenix, Arizona manufacturing facility is working on the final assembly of a Sabre automatic press.

1 MANUAL PRINTING PRESSES	
The Odyssey Series	4-7
The Mach Series	8-9
2 AUTOMATIC PRINTING PRESSES	
The Freedom Express	10-11
The Cutlass Series	12-13
The Sabre Series	14-15
3 CONVEYOR DRYERS	
Powerhouse Series II	16-17
Powerhouse Series	18-19
Compact	19
MD-8	20-21
4 PRE-PRESS EQUIPMENT	
LED Exposure Units	22
Photosharp	23
Lumitron UV	23
Pre-Registration System	24
Computer to Screen System	25
5 FLASH CURING UNITS	
Automatic Units	26
Manual Units	27
6 SPECIALTY EQUIP & ACCESSORIES	
N-Series Number System	28-29
SD 10 Screen Dryer	30-31
Gripper and Vacupallet	31
Wash-It Systems	32
Accu-Stretch	33
CapMax Cap Printers & Accessories	34
7 SAMPLE SHOP PACKAGES	
Starter Packages	35
Professional Packages	35

EVER USED A TABLET BEFORE? THEN YOU'RE READY TO PRINT SOME SHIRTS.

FROM YOUR DESKTOP...

Workhorse Products has taken the leading role in shop evolution. Our Workhorse operating system has carved the path of complete hardware & software integration and communication. Whether it's the ability to see what your press is doing at all times from anywhere in the world, or our automatic press software upgrades giving you access to the latest features possible, Workhorse gives you a leg up on your competition.

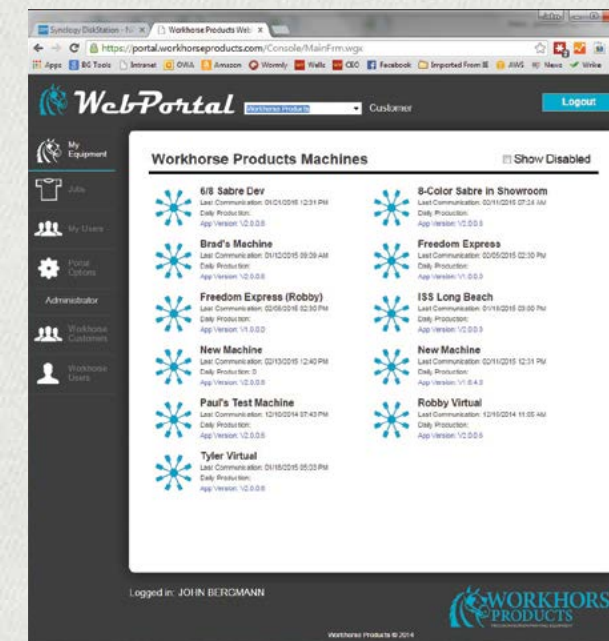

From the web-based portal, machine owners can see an overview of each machine and vital daily statistics for each machine. Then, by clicking on a machine icon, the current print job and pending jobs including artwork and job setup information can be displayed.

...AND THE PRODUCTION FLOOR.

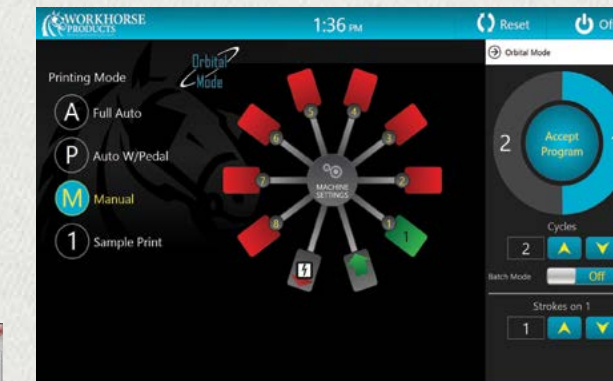

Our graphics based Orbital Programming is the easiest way to use multiple revolutions for high flash requirements, up to 9 revolutions per job!

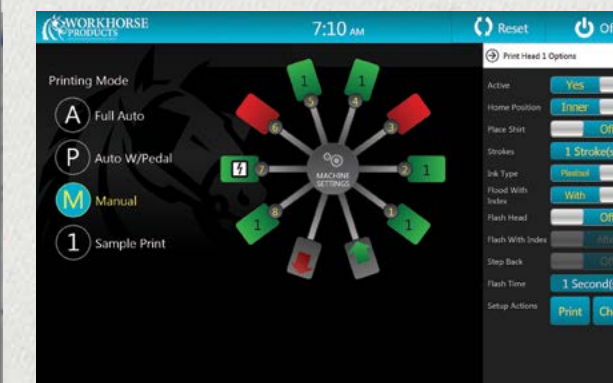

With more flexibility than any other machine, our print head menu is concise and easy to use. Change print direction, ink type, stroke count, flash time, flash settings and other functions all with a simple touch of the control.

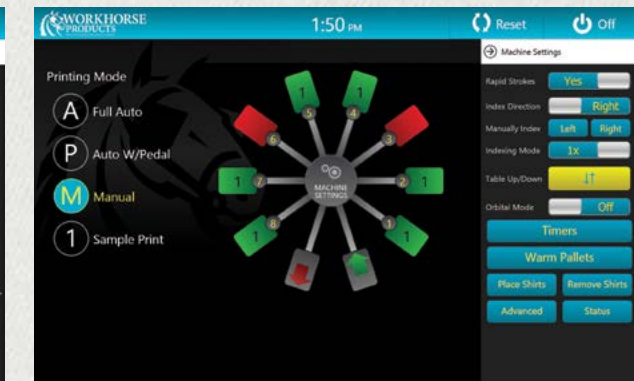

An easy to read touch menu allows quick and easy access to all machine parameters such as index direction, specialty ink modes, indexing mode, etc.

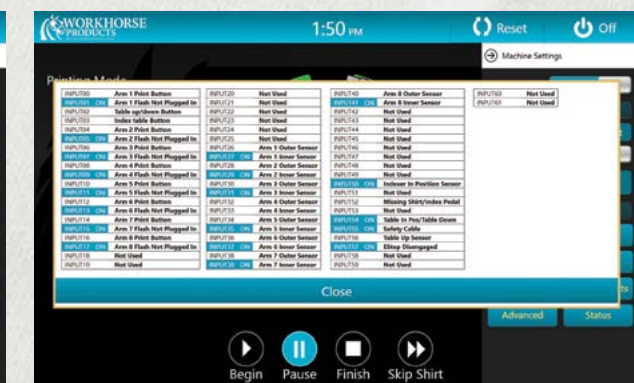

With an intuitive I/O status screen which Workhorse Technical Services can see remotely, any questions that arise can be dealt with efficiently.

1

MANUAL PRINTING PRESSES

ODYSSEY BENCHTOP MODELS

The Odyssey bench model printers have a compact tabletop design with an economical price point. This makes them great for start up shops or as a second press to print short run jobs. These presses are light weight and very easy to travel with. Take any of the Odyssey bench model presses to your next event for on-site screen printing.



O4100B

This is our most popular table top press. This bench model press gives you 4 color capability at a budget price while being the most sturdy and durable bench model press on the market.

PRINT HEAD W/MICRO REGISTRATION



The new print heads include a spring loaded micro registration system with easy to adjust handles and knobs. The spring loaded system has minimal to no backlash when in use to allow for the smallest of on head adjustments.

CAPTURE FORK AND BEARING REGISTRATION SYSTEM



Different from the nylon bolt style of the past, this system is derived from the same time tested registration used on all of our automatic presses. This system provides little to no wear and with no adjustments needed; this offers a lifetime of use with no fuss.

PRINT ARM CRADLE BRACKET

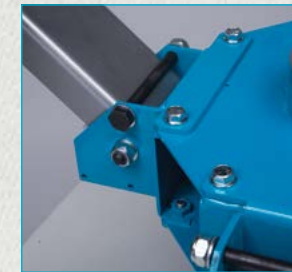

This strengthened arm support system utilizes a flat plate, four point flush mounted connection. This new bracket and connection provides a stronger more stable print arm with minimal pallet deflection.

COVERED SPRING CARTRIDGE



A covered die compression spring cartridge has replaced the exposed extension springs. The compression springs provide a longer life span and are available with multiple tensions settings from the factory. Covering them below the print head also provides a more secure setting for the springs.

HONEYCOMB TURRET DESIGN

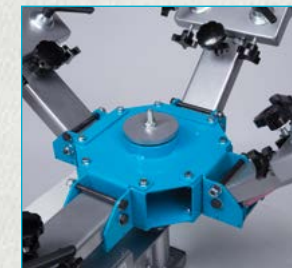

This re-designed turret provides an easier to use carousel with improved structural support.



O2100B

Our two color one station bench model press is the ideal entry level machine for multiple-color printing. It has the ability to add additional colors if needed and is one of the most inexpensive ways to start or expand your printing needs.

O1100B

This machine is ideal for printing single color jobs on shirts, sleeves, tote bags, name drops, tagless labels, etc. without interrupting your large production machines. Add a cap, jacket or vacuum attachment and convert this machine into a dedicated special purpose printer.

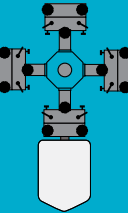
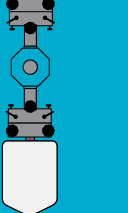
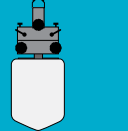
			
Model Number	O4100B	O2100B	O1100B
Part Number	OD-41-MP	OD-21-MP	OD-11-MP
Colors/Stations	4 Colors/1 Station	2 Colors/1 Station	1 Color/1 Station
Max Screen Width	32" (81 cm)	N/A	N/A
Dimensions (L x W x H)	56" x 38" x 27" 142 cm x 97 cm x 69 cm	56" x 38" x 27" 142 cm x 97 cm x 69 cm	34" x 14" x 27" 86 cm x 36 cm x 69 cm
Weight	170 lbs. (77 kg)	120 lbs. (55 kg)	50 lbs. (23 kg)

1

MANUAL PRINTING PRESSES

ODYSSEY FLOOR MODELS

The newly redesigned Odyssey Manual Printers are value priced industrial machines with high quality professional upgrades. While this is our "Entry Level" machine, it is unmatched in its class. The Odyssey line is ideal for start-up operations such as home-based business, sporting goods retailers and other decorated apparel companies that want to add a screen printing department. Because of its durable design, the Odyssey will not only help you begin your business, it will also remain reliable as you continue to grow.

	O4400F	O6400F
Model Number	O4400F	O6400F
Part Number	OD-44-MP	OD-64-MP
Colors/Stations	4 Colors/4 Station	6 Colors/4 Station
Max Screen Width	44" (112 cm)	25" (64 cm)
Dimensions (Dia x Hgt)	90" x 34-36" 229 cm x 86-91 cm	90" x 34-36" 229 cm x 86-91 cm



HONEYCOMB TURRET DESIGN

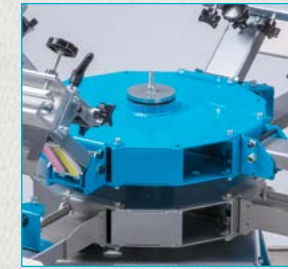

These re-designed turrets (upper and lower) provide an easier to use carousel with improved structural support.

CAPTURE FORK AND BEARING REGISTRATION SYSTEM



Different from the nylon bolt style of the past, this system is derived from the same time tested registration used on all of our automatic presses. This system provides little to no wear and with no adjustments needed; this offers a lifetime of use with no fuss.

PRINT HEAD w/MICRO REGISTRATION



The new print heads include a spring loaded micro registration system with easy to adjust handles and knobs. The spring loaded system has minimal to no backlash when in use to allow for the smallest of on head adjustments.

COVERED SPRING CARTRIDGE



A covered die compression spring cartridge has replaced the exposed extension springs. The compression springs provide a longer life span and are available with multiple tension settings from the factory. Covering them below the print head also provides a more secure setting for the springs.

QUICK RELEASE RUBBER COATED ALUMINUM PALLETS



Floor model presses come standard with a quick release pallet and bracket system. Each press will also include a set of rubber coated aluminum pallets. This allows for quick change overs and pallet compatibility with other presses.

EXTENDED CENTER SHAFT



The shaft is now twice as long and supported at the bottom. This provides over five times the strength as before and creates additional support to all portions of the press.

PRINT ARM CRADLE BRACKET

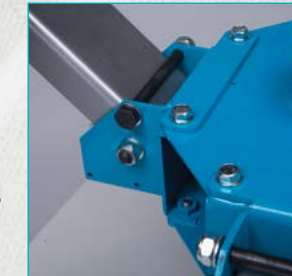

This strengthened arm support system utilizes a flat plate, four point flush mounted connection. This new bracket and connection provides a stronger more stable print arm with minimal pallet deflection.

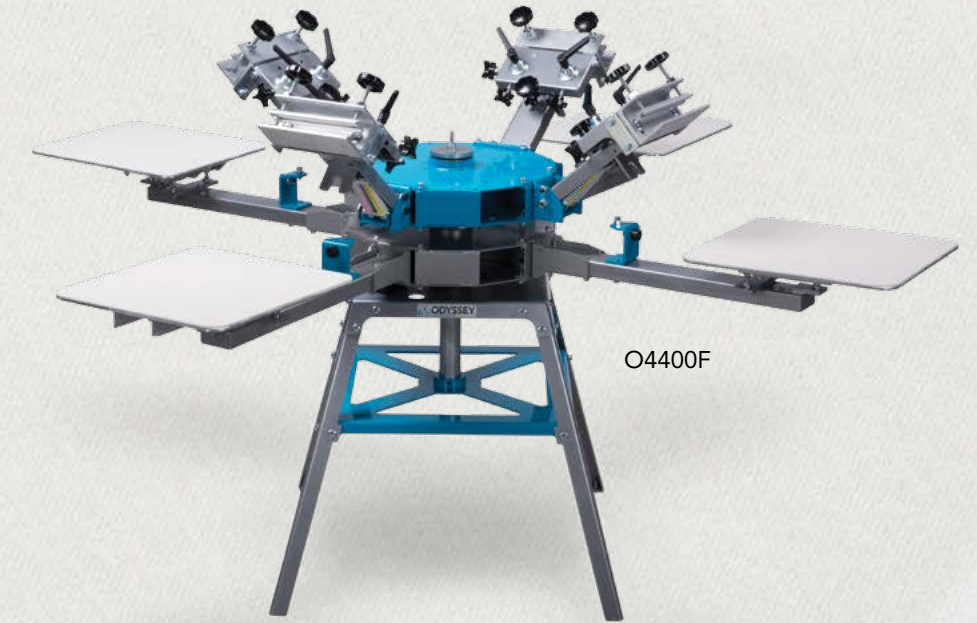

O4400F

O6400F

MANUAL PRINTING PRESSES

MACH SERIES

THE PROFESSIONALS CHOICE! This press was designed for the printer who makes his or her living behind a squeegee. Light enough for ease of use day in and day out, but solidly welded to provide a rigid platform for life. The Mach printers are ideal for growing and high volume shops producing sophisticated designs. The large diameter, full length center shaft combined with print station support struts maximize rigidity. The precision-machined, cast aluminum print heads and center wheel provides extremely tight registration. With the optional cap, jacket, sign, coozie, sticker and pocket attachments, this machine is the do it all answer for any shop. Combined with the tool free X, Y, and Z micro registration, this machine is the best of all worlds. Mach printers also come in a variety of sizes to fit your printing needs.

SOLID CONSTRUCTION



Print arm struts ensure that platens remain square and stable while maximizing strength.



Welded structural steel construction is the key to a lifetime of tight registration. Our large diameter center shaft with tapered bearings give unmatched stability and accuracy.



The light weight, precision machined, single cast aluminum center wheel provides the tightest registration with smooth quick turns.

ADVANCED PRINT HEAD DESIGN



All print heads are precision machined cast aluminum with tool free, dial-in off contact. Built with large diameter registration knobs that provide super responsive X,Y & Z micro registration and screen angle adjust.



M-64-O

LOCKABLE CASTER OPTION



Mobilize your Mach Series Manual Printer with a new set of lockable casters.

SIDE CLAMP OPTION



For our customers who prefer a side clamp press, we can accommodate your preference.

QUICK-RELEASE RUBBER COATED ALUMINUM PALLET



Increase the compatibility of your pallets across all your shop presses with an optional universal quick-release system.

MACH MANUAL PRINTER MODELS

Model Number	M-44-M	M-64-O	M-66-M	M-86-O	M-88-O
Part Number	10005	10011	10007	10010	10009
Colors/Stations	4 Colors/4 Stations	6 Colors/4 Stations	6 Colors/6 Stations	8 Colors/6 Stations	8 Colors/8 Stations
Max Screen Width	32" (81 cm)	23" (58 cm)	26" (66 cm)	21" (53 cm)	26" (66 cm)
Dimensions (Diameter x Height)	103" x 34-36" 262 cm x 86-91 cm	103" x 34-36" 262 cm x 86-91 cm	111" x 34-36" 282 cm x 86-91 cm	111" x 34-36" 282 cm x 86-91 cm	130" x 34-36" 330 cm x 86-91 cm



MACH M-66-A

Model Number	M-44-A	M-66-A	M-88-A
Part Number	10004	10006	10008
Colors/Stations	4 Colors/4 Stations	6 Colors/6 Stations	8 Colors/8 Stations
Max Screen Width	32" (81 cm)	26" (66 cm)	26" (66 cm)
Dimensions (Diameter x Height)	96" x 34-36" 244 cm x 86-91 cm	105" x 34-36" 267 cm x 86-91 cm	130" x 34-36" 330 cm x 86-91 cm

2

AUTOMATIC PRINTING PRESSES

FREEDOM EXPRESS

Workhorse introduces the premier entry-level automatic on the market—the new Freedom Express. Following the design of the ground breaking Sabre, the Freedom Express offers features you wouldn't expect to find in an entry-level press. Featuring the state-of-the-art Workhorse Operating System, this is the easiest entry-level press to operate and maintain. The Freedom Express can run your 20"x 24" or 20"x 28" frames for the maximum image. This is the perfect press to move you from manual to automatic printing. Utilizing the Owners Portal gives you a free and easy flow of information between your office and the machine. The feature rich Freedom Express is the greatest value for anyone entering the world of automatic printing.

LOCKABLE REAR SCREEN HANGER



CENTRAL OFF CONTACT



Operators have the ability to quickly change between different substrates with the fast and easy central off contact feature.

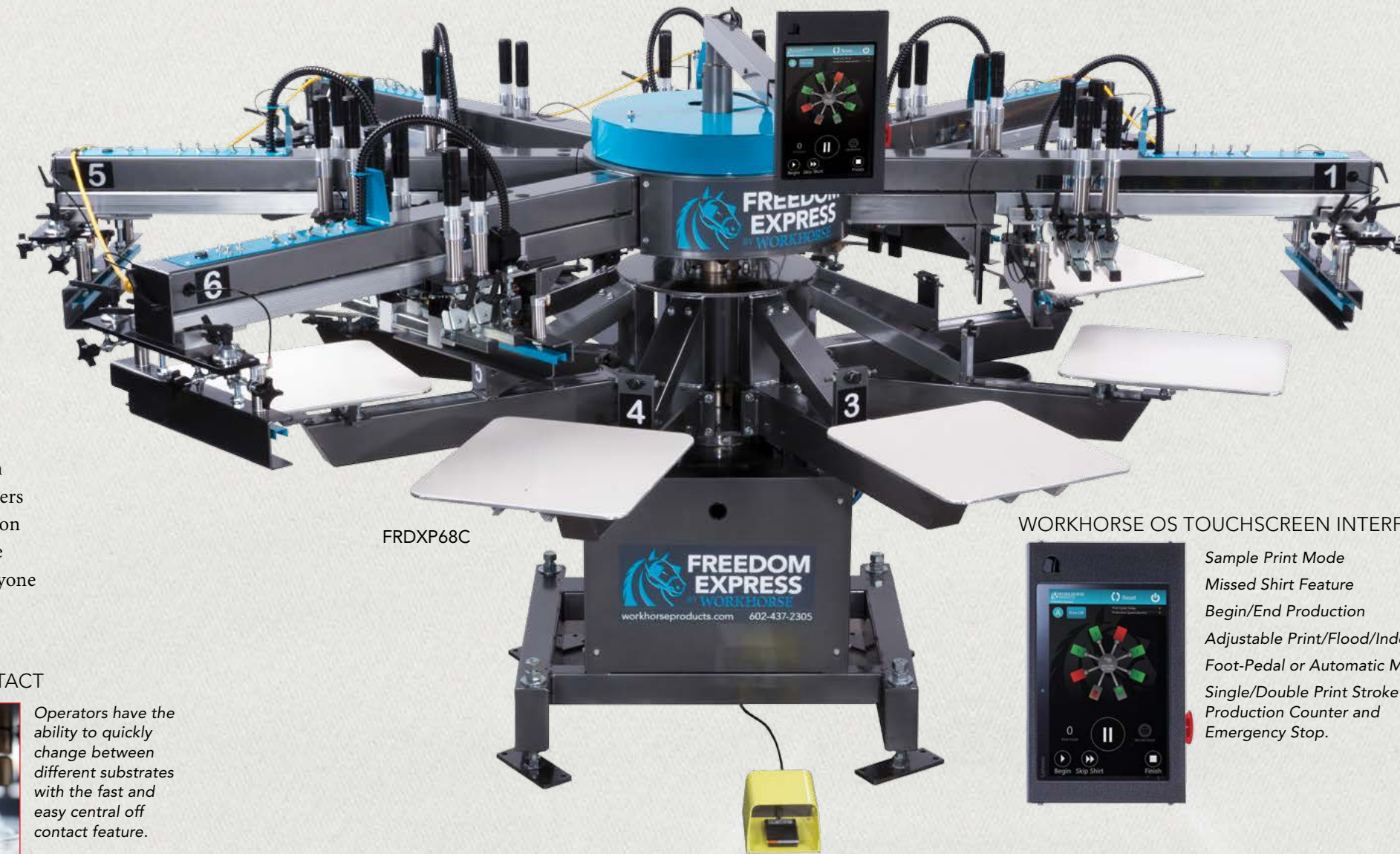

FRDXP68C

WORKHORSE OS TOUCHSCREEN INTERFACE



- Sample Print Mode
- Missed Shirt Feature
- Begin/End Production
- Adjustable Print/Flood/Index Delay
- Foot-Pedal or Automatic Mode
- Single/Double Print Stroke with Production Counter and Emergency Stop.

ON-HEAD PRINT CONTROLS



Independent print and flood speed with front and rear pneumatic screen clamp switches. Table up/down, index and print buttons.

FRONT AND REAR MICRO REGISTRATION

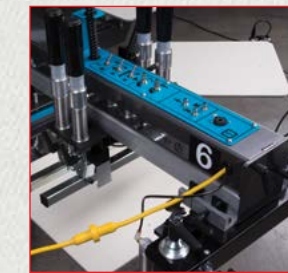

Super-responsive front and rear micro registration comes standard. Precision grid patterns provide excellent control and visibility of screen position.

FOOT PEDAL CONTROL



Foot pedal control comes standard on every press. This allows the press operator to index the machine or use the pedal as a skip shirt feature to avoid printing on empty pallets or misaligned shirts.

CHOPPER SYSTEM



Advanced chopper system improves stroke length to increase image area. Default up-state keeps squeegee & floodbar up off of screen and facilitates easy set-up and tear-down by allowing more screen clearance.

Angle reference marks every 5° for squeegee and floodbar.

FLASHBACK COMPATIBLE



The patented FlashBack is the only system on the market that allows you to print, flash, and cool all at one station. This means a six color printer can truly print six colors. (see page 26)

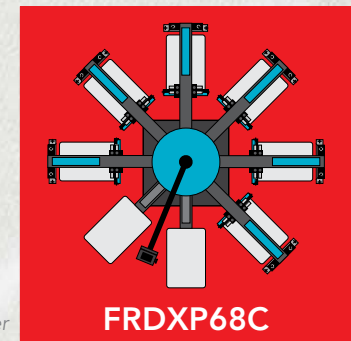

FRDXP68C

Model Number	FRDXP68C
Part Number	FXP-68-PC
Colors/Stations	6 Colors/8 Stations
Standard Print Area	15" x 15" (38 cm x 38 cm)
Production Capacity	400-500 (35-45 doz.) /hr.
Power Requirements	ELECTRIC 110V, 50-60Hz, 5amps AIR 110psi (7.6 bar), 23cfm (651 L/M)
Diameter	10' (3.0 m)

2

AUTOMATIC PRINTING PRESSES

CUTLASS SERIES

Workhorse delivers the ultimate in hardworking style. The Cutlass SE is designed with the everyday rigors of your print shop in mind. The Cutlass offers practical, easy to use pneumatic printheads and features a powerful, efficient and precise electric indexing system. Powered by the industry leading Workhorse OS, all of the options you need to take control are right at your fingertips. The Cutlass encompasses the same proven build quality that Workhorse is known for and with an economical price point, the Cutlass is the most functional and affordable press in its class.

Features:

- ▶ Workhorse OS with Orbital Mode
- ▶ Electric Index
- ▶ On Head Print Controls
- ▶ Flashback Compatible
- ▶ 20" x 20" Print Area
- ▶ 6 and 8 Color Configurations
- ▶ Full diagnostic and testing from touch screen control
- ▶ On the fly timer and stroke changes
- ▶ Real-time production and count data

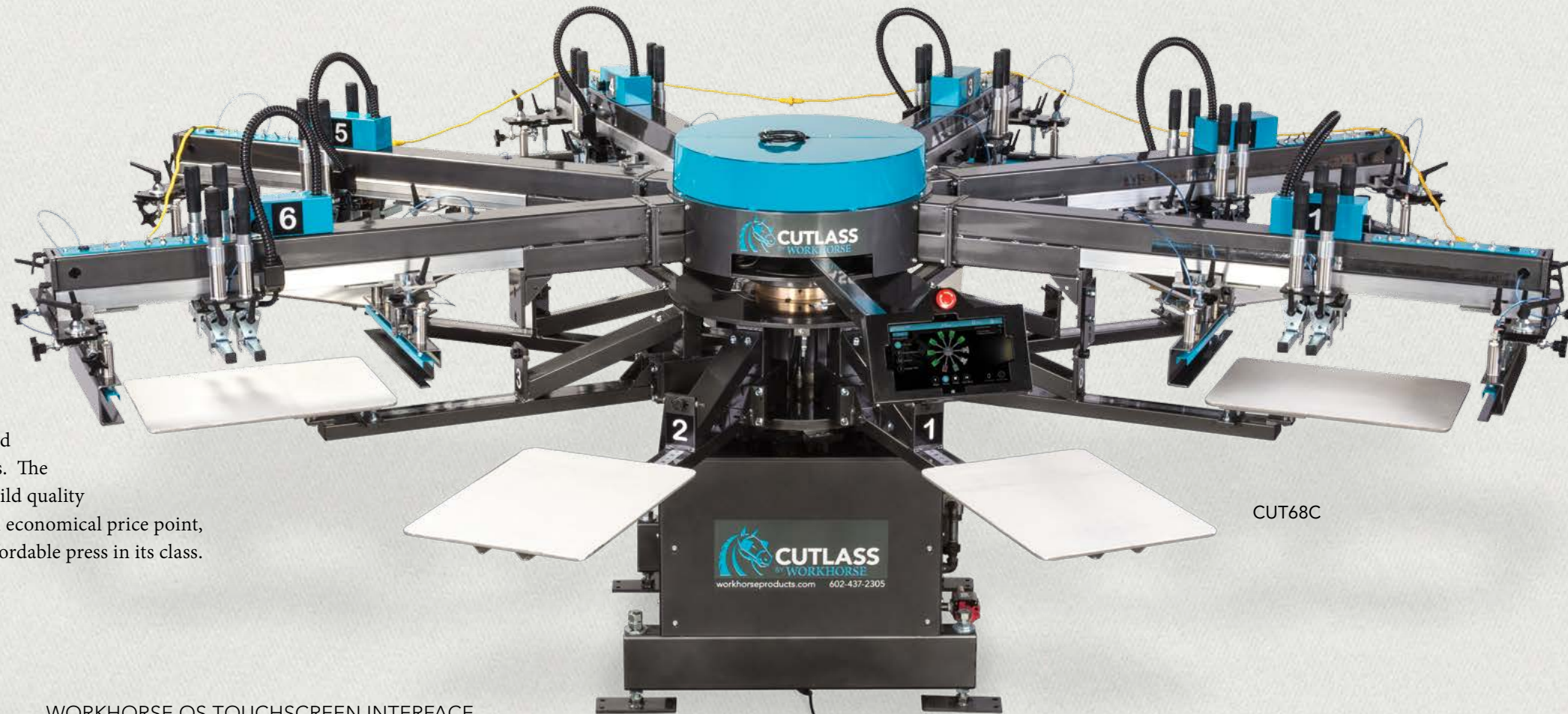

CUT68C

WORKHORSE OS TOUCHSCREEN INTERFACE

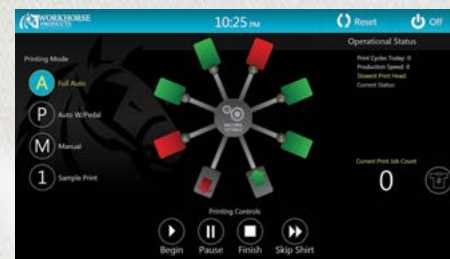

Multiple (1-9) print stroke capability.
 Multi-print in the up position.
 Onboard self-diagnostics.
 Pivoting control panel with touch-screen display.
 Real-time production data.
 Countdown program indicates when operator set index count has been reached.
 Independent print-start/print-finish setting automatically activates and stops printheads at the beginning and end of production runs.

FOOT PEDAL CONTROL

Foot pedal control comes standard on every press. This allows the press operator to index the machine or use the pedal as a skip shirt feature to avoid printing on empty pallets or misaligned shirts.

ON-HEAD PRINT CONTROLS

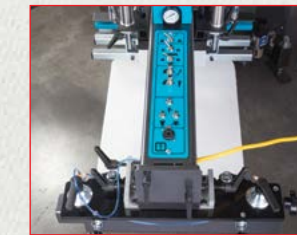

Independent print and flood speed with front and rear pneumatic screen clamp switches. Table up/down, index and print buttons.

FLASHBACK COMPATIBLE



The patented FlashBack is the only system on the market that allows you to print, flash, and cool all at one station. This means a six color printer can truly print six colors. (see page 26)

FRONT AND REAR MICRO REGISTRATION



Super-responsive front and rear micro registration comes standard. Precision grid patterns provide excellent control and visibility of screen position.

NEW CHOPPER SYSTEM

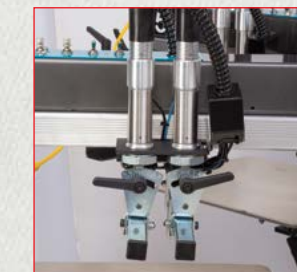

Advanced chopper system improves stroke length to increase image area. Default up-state keeps squeegee & floodbar up off of screen and facilitates easy set-up and tear-down by allowing more screen clearance.
 Angle reference marks every 5° for squeegee and floodbar.

Simple design makes maintenance a breeze

Fast and easy print heads with 100% pneumatic controls, mechanical stroke-length adjustments and all access control panel, eliminates the maintenance associated with automatic machines.

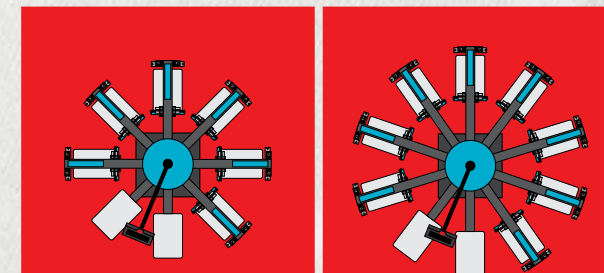

Model Number	CUT68C	CUT810C
Part Number	CE-68-PC	CE-810-PC
Colors/Stations	6 Colors/8 Stations	8 Colors/10 Stations
Standard Print Area	20" x 20" (50.8 cm x 50.8 cm)	20" x 20" (50.8 cm x 50.8 cm)
Production Capacity	600-700 (50-60 doz.) /hr.	600-700 (50-60 doz.) /hr.
Power Requirements	ELECTRIC 1 Phase 220V, 5 amps	ELECTRIC 1 Phase 220V, 6 amps
	AIR 110psi (7.6 bar), 22cfm (623 L/M)	AIR 110psi (7.6 bar), 24cfm (680 L/M)
Diameter	12'-6" (3.8 m)	14' (4.27 m)

2

AUTOMATIC PRINTING PRESSES

SABRE SERIES

The Sabre Series line of automatic presses has set the standard for high production and high quality at an affordable price. Workhorse combines their 30 year history of quality products, services and resources with some of the latest screen printing technologies. These technologies include a revolutionary patent pending indexing system and a never before seen touch screen control panel offering unmatched functionality.

The Sabre is available in 6, 8, 10 and 12 color configurations. All models feature our patented flashback capabilities, a pivoting control panel with touch-screen display, micro-registration, independent floodbar and squeegee pressure adjustments and quick release pallets with a standard 20" x 20" (51 cm x 51 cm) image area.

Features:

- ▶ Clockwise or counterclockwise carousel indexer
- ▶ Central off-contact
- ▶ UL and CE approved components
- ▶ Tool free quick release pallet system
- ▶ Front and rear stroke length adjustments



SAB810

WORKHORSE OS TOUCHSCREEN INTERFACE

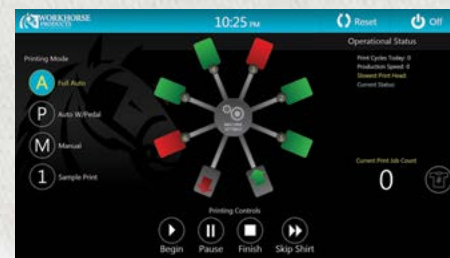

Multiple (1-9) print stroke capability.

Multi-print in the up position.

Onboard self-diagnostics.

Pivoting control panel with touch-screen display.

Real-time production data.

Countdown program indicates when operator set index count has been reached.

Independent print-start/print-finish setting automatically activates and stops printheads at the beginning and end of production runs.

FOOT PEDAL CONTROL

Allows indexing of the press using a foot pedal. Skip-Shirt foot pedal feature allows operators to avoid printing empty pallets.



INDEX SYSTEM

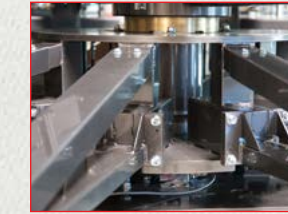

Patent pending AC/electric indexer. Precision indexing for faster speeds. Zero-delay double indexing. Multiple station indexing.

CHOPPER SYSTEM



Advanced chopper system improves stroke length to increase image area. Default up-state keeps squeegee & floodbar up off of screen and facilitates easy set-up and tear-down by allowing more screen clearance. Angle reference marks every 5° for squeegee and floodbar.

PRINTHEADS



Plug N Go flash capabilities. Independent print/flood speed controls, on each printhead. AC/electric driven printheads.

REGISTRATION



Compatible with most Pin registration systems. Enhanced front micro-registration adjustments with visual guides.

Model Number	SAB68	SAB810	SAB1012	SAB1214
Part Number	SE-68-EC	SE-810-EC	SE-1012-EC	SE-1214-EC
Colors/Stations	6 Colors/8 Stations	8 Colors/10 Stations	10 Colors/12 Stations	12 Colors/14 Stations
Standard Print Area	20" x 20" (51 cm x 51 cm)	20" x 20" (51 cm x 51 cm)	20" x 20" (51 cm x 51 cm)	20" x 28" (51 cm x 71 cm)
Production Capacity	750-850 (60-70 doz.) /hr.	750-850 (60-70 doz.) /hr.	750-850 (60-70 doz.) /hr.	750-850 (60-70 doz.) /hr.
Power Requirements	ELECTRIC 220V, 50-60Hz, 13amps AIR 110psi (7.6 bar), 5cfm (142 L/M)	ELECTRIC 220V, 50-60Hz, 16amps AIR 110psi (7.6 bar), 6cfm (170 L/M)	ELECTRIC 220V, 50-60Hz, 20amps AIR 110psi (7.6 bar), 7cfm (198 L/M)	ELECTRIC 220V, 50-60Hz, 25amps AIR 110psi (7.6 bar), 12cfm (340 L/M)
Diameter	12'6" (3.8 m)	14' (4.3 m)	15'6" (4.7 m)	18' (5.5 m)
				Not compatible with the Flashback

3

CONVEYOR DRYERS POWERHOUSE SERIES DRYERS

POWERHOUSE SERIES II

Not just for plastisol anymore! The Powerhouse Series II cures plastisol and water-based ink systems as well as other evaporative cured inks at industrial rated production speeds. The control center is managed via a touch screen tablet which is easy to use while providing you much more information than ever before. A ground up redesign of the air handling system now offers a powerful yet controllable air flow that is easily matched to your ink system. Touch screen control, adjustable height heaters, adjustable air volume and various sizes for any production requirement. This is your next Dryer.

Features:

- ▶ Advanced Air Flow & Air Handling
- ▶ Touch Screen Tablet Control Center
- ▶ Infrared Radiant Panel Heating Elements
- ▶ Conveyor Belt System



PD5409-4

NEW TOUCH SCREEN CONTROL PANEL



Tablet Control with Workhorse OS

Digital temperature read out indicating set temp and actual temp

Gradual warm up & maintaining even temperatures

Actual belt speed indicator

Power consumption

Auto cool down mode when dryer is shut down

Access to Workhorse portal for tracking temperature, belt speed & power cost of individual jobs



PD3009-4

Model Number	PD5409-3	PD5409-4	Model Number	PD3009-3	PD3009-4
Part Number	PD5409-3-1P(3P)	PD5409-4-1P(3P)	Part Number	PD3009-3-1P(3P)	PD3009-4-1P(3P)
Belt Size	54" x 9' (137cm x 275cm)	54" x 9' (137cm x 275cm)	Belt Size	30" x 9' (76cm x 275cm)	30" x 9' (76cm x 275cm)
Production Capacity	900+ /HR – plastisol 300-400 / HR – waterbased	950+ /HR – plastisol 400+ / HR – waterbased	Production Capacity	400-500 /HR – plastisol 100-200 /HR – waterbased	450-550 /HR – plastisol 200+ /HR – waterbased
Power Requirements	ELECTRIC 1-Phase: 240V, 50-60Hz, 22,217W, 58A	ELECTRIC 3-Phase: 240V, 50-60Hz, 29,417W, 76A	Power Requirements	ELECTRIC 1-Phase: 240V, 50-60Hz, 11,309W, 47A OPTIONAL 3-Phase, 240V, 50-60Hz, 11,417W, 31A	ELECTRIC 1-Phase: 240V, 50-60Hz, 14,909W, 62A OPTIONAL 3-Phase, 240V, 50-60Hz, 15,017W, 40A
Infeed/Exit x Chamber	26" x 54" (66cm x 137cm)	26" x 54" (66cm x 137cm)	Infeed/Exit x Chamber	26" x 54" (66cm x 137cm)	26" x 54" (66cm x 137cm)

3

CONVEYOR DRYERS POWERHOUSE SERIES DRYERS

POWERHOUSE QUARTZ DRYERS

Quartz technology makes the difference. Our claim to fame with the Powerhouse series is our true understanding of Infrared energy, its emission, and how it affects different materials. Our Quartz technology provides near instant-on capabilities for curing plastisols. With warm up times in seconds and not minutes, it's no wonder shop owners look to us for higher productivity. The Powerhouse Series' 180 degree radiant pattern of emission means energy strikes from all angles, unlike standard panel dryers that only omit energy perpendicular to the panel. Simply put, the quartz technology in the Powerhouse Series provides a more uniform cure; even on shirts that are not perfectly flat. For waterbase and discharge printing, the Powerhouse Series incorporates a convection system of blowers and air knives to scrub the garments with hot air. The Powerhouse hybrid IR and Convection system allows us to cure more garments per hour in less space and at a lower price. Our digital control center uses state-of-the-art electronics and solid state components to accurately manage temperature and belt speed.

Features:

- ▶ Adjustable oven doors help to retain oven temperature
- ▶ Removable oven hood provides easy access for regular cleaning
- ▶ 4-point belt tracking makes it easy to setup your dryer and extends belt life
- ▶ Optional add-on in feed and out feed facilitates garment loading and unloading



PQ-2608

LOCKABLE CASTER SYSTEM



With a set of lockable casters, you can maximize your work space by easily moving your Powerhouse Dryer around your entire shop.

Model Number	PQ-2608	PQ-3011	PQ-5208	PQ-4013	PQ-5217
Part Number	11212	11226	11272	11237	11248
Belt Size	26" x 8' (66 cm x 2.4 m)	30" x 11' (76 cm x 3.3 m)	52" x 8' (132 cm x 2.4 m)	40" x 13' (102 cm x 3.9 m)	52" x 17' (132 cm x 5.1 m)
Production Capacity	200-300/hr.	400-500/hr.	400-500/hr.	600-800/hr.	1000+/hr.
Power Requirements	ELECTRIC 1-Phase, 220V, 50-60Hz, 8400 Watts, 50amps 3-Phase, 220V, 50-60Hz, 9100 Watts, 24amps	ELECTRIC 1-Phase, 220V, 50-60Hz, 12000 Watts, 56amps 3-Phase, 220V, 50-60Hz, 12000 Watts, 38amps	ELECTRIC 1-Phase, 220V, 50-60Hz, 10900 Watts, 53amps 3-Phase, 220V, 50-60Hz, 10900 Watts, 29amps	ELECTRIC 1-Phase, 220V, 50-60Hz, 18000 Watts, 82amps 3-Phase, 220V, 50-60Hz, 18000 Watts, 56amps	ELECTRIC 3-Phase, 220V, 50-60Hz, 30600 Watts, 91amps
Infeed/Exit x Chamber	24" x 48" 61 cm x 122 cm	36" x 60" 91 cm x 132 cm	24" x 48" 61 cm x 122 cm	36" x 84" 91 cm x 213 cm	60" x 84" 132 cm x 213 cm

ODYSSEY COMPACT CONVEYOR DRYERS

These compact dryers allow you to produce professional, long lasting images even with a limited space or budget. The double wall construction and adjustable oven doors retain oven heat while the exhaust flange allows removal of fumes from your shop. These dryers handle a wide variety of imprintables, caps, jackets, sweats, and transfers just to name a few.

Features:

- ▶ Adjustable belt speed and oven doors
- ▶ Large heat panel
- ▶ Double wall construction
- ▶ Exhaust connection



CD227

Model Number	CD205	CD227
Part Number	11208/11209	11205
Belt Size	20" x 5'5" (51 cm x 1.7 m)	22" x 7' (56 cm x 2.1 m)
Production Capacity	60-70/hr.	120+/hr.
Power Requirements	ELECTRIC 1-Phase, 115V, 50-60Hz, 2000Watts, 17amps OPTIONAL 1-Phase, 220V, 50-60Hz, 3000Watts, 14amps	ELECTRIC 1-Phase, 220V, 50-60Hz, 6200Watts, 27amps
Infeed/Exit x Chamber	18" x 30" 46 cm x 76 cm	18" x 48" 46 cm x 122 cm

3 CONVEYOR DRYERS MD8 SERIES DRYERS

WORKHORSE MD8 SERIES

The MD8 is a compact, powerful gas fired dryer designed to cure a wide variety of substrates. The MD8 has many of the features commonly found with larger dryers combined with a space savings footprint and competitive price. This dryer is designed to cure all types of screen printed, digital printed and other coated products. The MD8 offers a patented Air Deflector Recycling System that re-circulates heated air through the heat chamber providing some of the most efficient and balanced curing on the market.

The drying process uses high velocity air and balanced air flow at a process speed of 1 ft./min up to 25 ft./min. Specially formed jet nozzles in the dryer hood provide high velocity air and heat convection with a 7.5 HP blower generating balanced air flow. This air nozzle heat distribution feature is typically found only on dryers that cost much more. The blower has a re-circulating air capacity of 6,000 CFM. Cure temps range from 260° to 450°F for efficient drying of the ink with temperature accuracy of ± 2% of set temperature up to 450°F.

Features:

- 36", 48" and 60" belt widths
- Additional hot air and infeed/exit conveyor attachments
- Patented air deflector recycling system
- Powerful 250,000 BTU stainless steel burner
- Slide out easy-clean filter drawer
- Higher velocity jet nozzles for better air distribution
- Side access clean out door
- Enlarged heat plenum for maximum air velocity
- UL and CE approved components



STANDARD 8' OVEN SECTION

Each dryer section is made with double wall insulated construction comprised of Aluminized Steel (non-corrosive) sheet metal for a high temperature interior. Within the double walls is 3" thick insulation and heat brake lines to keep the heat inside the dryer with minimum heat loss. The exterior is painted with thick industrial powder coating and all fans are mounted within the footprint of the dryer without any parts protruding from the sides.

EASY ACCESS CONTROLS

This user friendly, large ergonomic control panel has many valuable functions. Functions include: conveyor speed control with illuminated digital display, 1-25 ft./min. An Athena air temperature control with PD function and display for set and actual value. Digital settings with alarm function, max 360°F with blower, fans on/off, heat on/off and separate on-off controls for the 3 IR sections.

HIGH TEMP SELF-TRACKING BELT

The 36" to 60" wide black mesh conveyor belt (order specific) is made of a heavy duty Teflon coated glass. A belt tracking system is in place to correct any side to side drift off of the conveyor. A 1 HP conveyor drive motor with speed regulator and digital read out of conveyor speed 1-10 m/min powers the belt.

OPTIONS

- Infra-Red Panel
- Cooling Sections
- Additional Conveyor Sections
- Hi-Temp Feature: Up to 450 Degrees
- Electric Hot Air Burner
- Automatic Doffing System for Flat Goods
- UV Curing Capability with Vacuum Hold Down
- Split Belts with Independent Speed Adjustments

	Model Number	MD848	MD860
Part Number		MD84808	MD86008
Belt Size		48" x 16' (122cm x 24.8m)	60" x 16' (152cm x 24.8m)
Production Capacity		600-800/hr.	1000+/hr.
Power Requirements		ELECTRIC 3-Phase, 220V, 50-60Hz, 35amps GAS Natural or Propane 6-12" w/c 3/4" npt	ELECTRIC 3-Phase, 220V, 50-60Hz, 35amps GAS Natural or Propane 6-12" w/c 3/4" npt
Dimensions (L x W x H)		16' x 82" x 32" 18.6m x 208cm x 81cm	16' x 97" x 32" 18.6m x 246cm x 81cm

4

PRE-PRESS EQUIPMENT

LUMITRON LED EXPOSURE UNIT

These tabletop and stand alone units deliver fast, uniform and high resolution exposures using long lasting LED light strips. In addition to the fast exposure times and fine line detail, this unit will reduce your set up times, energy costs and overall cost of ownership. Unlike expensive metal-halide bulbs that require regular replacements, run at high temperatures and require startup and cool down time, the LED strips operate at much lower temperatures, can last over 50,000 hours and start and stop immediately with the touch of a button. Workhorse has also taken the lead by offering their line of exposure units at the most affordable price on the market.

FEATURES:

- ▶ Easy to operate digital control timer
- ▶ Powerful, oil-free vacuum pump
- ▶ Flexible neoprene blanket to ensure film to screen contact
- ▶ Gas shock operated blanket frame for easy opening
- ▶ Large exposing surface capable of holding up to 25" x 36" frames
- ▶ Optional legs available for tabletop units



LGLUM-LED



MDLUM-LED
(shown with optional legs)



SMLUM-LED

PHOTOSHARP METAL HALIDE EXPOSURE SYSTEM

PhotoSharp's performance is simply unmatched. PhotoSharp offers the highest resolution, fastest exposure times, and longest lamp life. The small focused lamp reflector maximizes image resolution. The shuttered lamp system provides faster exposure times by eliminating the warm up time associated with instant start systems and extends the lamps' life by reducing the number of lamp strikes. The dual-spectrum lamp is spectrally matched with both diazo and photopolymer sensitized emulsions for maximum speed and flexibility.

Features:

- ▶ 1000 watt metal halide light source
- ▶ Dual-spectrum, shuttered light source
- ▶ Small focused reflector
- ▶ Integrated digital time control and auto-shutoff and auto-repeat functions
- ▶ Extra large screen capacity
- ▶ Durable hold down blanket with powerful vacuum for perfect contact between screen and artwork
- ▶ Two-part cabinet for easy installation







LUMITRON UV FLUORESCENT EXPOSURE SYSTEM

The Lumitron is a high end exposure system in a small package. This unit has high output UV fluorescent bulbs that offer balanced light distribution throughout. Using the same powerful vacuum as our best units, the Lumitron gives you perfect contact between your film positive and screen.

Features:

- ▶ UV fluorescent light source provides balanced light distribution.
- ▶ Large screen capacity.
- ▶ Compact design to fit into any shop.
- ▶ Digital auto-shutoff timer with auto-repeat function.
- ▶ Durable hold down blanket with powerful vacuum for perfect contact between screen and artwork.

			
Model Number	SMLUM-LED	MDLUM-LED	LGLUM-LED
Part Number	11609	11610	11611
Max Screen Size	20" x 24" (51 cm x 61 cm)	25" x 36" (63 cm x 91 cm)	34" x 50" (86 cm x 127 cm)
Power Requirements	ELECTRIC 120V, 60Hz, 5 amps	ELECTRIC 115V, 60Hz, 5 amps	ELECTRIC 120V, 60Hz, 6 amps
Dimensions (L x W x H)	37" x 37" x 6" 94 cm x 94 cm x 15 cm	41" x 43" x 6" 104 cm x 109 cm x 15 cm	58" x 48" x 6" 148 cm x 122 cm x 15 cm

		
Model Number	LUMUV	PHSMH
Part Number	11598	11600B
Max Screen Size	23" x 31" (58 cm x 79 cm)	25" x 36" (63 cm x 91 cm)
Power Requirements	ELECTRIC 115V, 60Hz, 620 Watts, 6 amps	ELECTRIC 115V, 60Hz, 1400 Watts, 12 amps
Dimensions (L x W x H)	41" x 43" x 8" 104 cm x 109 cm x 20 cm	48" x 37" x 40" 122 cm x 94 cm x 102 cm

4

PRE-PRESS EQUIPMENT

PRE-REGISTRATION SYSTEM

Built for speed and accuracy, the Workhorse Registration System makes pre-registering your screens easier than ever. Simple to learn and use, anybody can be trained to quickly register screens.

Once you've burned your screens with the help of the exposure jig, all you have to do is simply connect the registration pallet to your press, move it to each print head, and pull the frames to touch the pallet at the registration points. Our Registration System is compatible with all Workhorse screen printing presses and may be used with wood frames, aluminum frames, and roller frames.

Convenience

The simplicity of our system will make pre-registration quick and easy, giving you more time to print. After you start using the Registration System, you'll wonder how you ever worked without it!

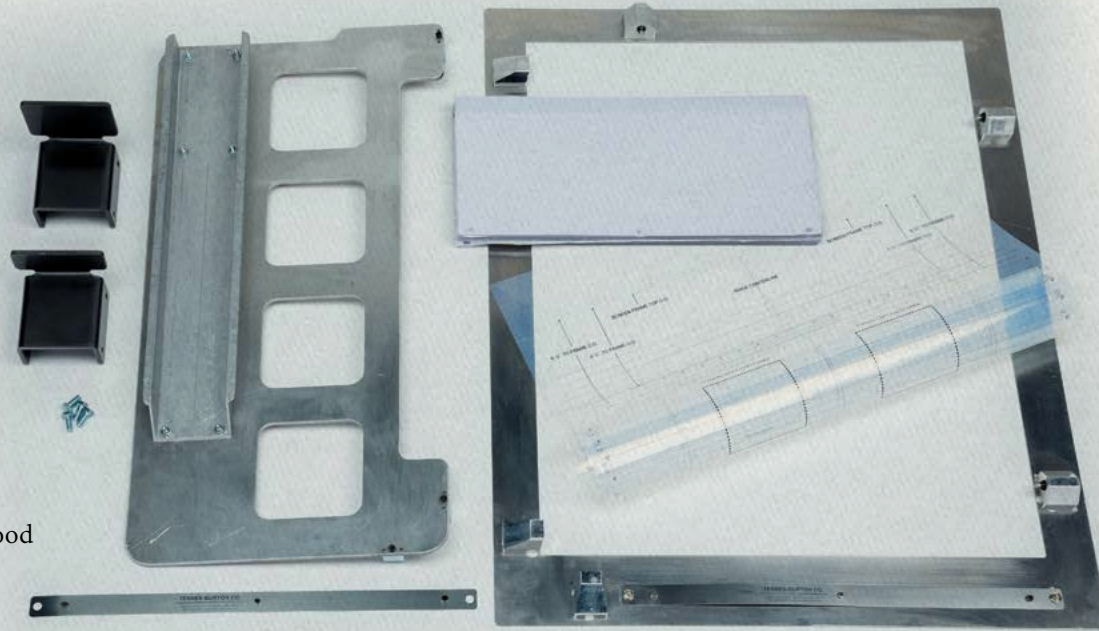

Part #	Model #	Complete Registration Package
PRS-2024	2024CRS	20" (51cm) wide x 24" (61cm) long
PRS-2028	2028CRS	20" (51cm) wide x 28" (71cm) long
PRS-2331	2331CRS	23" (58cm) wide x 31" (79cm) long
PRS-2536	2536CRS	25" (63cm) wide x 36" (91cm) long

COMPUTER TO SCREEN SYSTEMS

EXILE's new Spyder II direct-to-screen printer provides the ultimate in quality, while simplifying the process of creating screen masks. This high-resolution device can image screens at over two square feet per minute for extremely fast throughput. Perfect for the busy screen room, or any screen printer that is looking to eliminate film, reduce labor, speed up job turnaround, and improve print quality.

The Spyder II has a new, streamlined interface with easy to use touch screen controls. It boasts increased speed, resulting in nearly twice the throughput of the original Spyder, while simultaneously offering improved print quality with enhanced dot placement. With fewer, and modern, electronics the new Spyder II provides a simplified structure, improved performance, control and long term reliability.

The Spyder II uses heated wax ink with a robust, phase change inkjet head technology, to place a high-density image directly onto a coated screen. The system prints at 600 dpi, allowing halftone frequencies of up to 75 lpi. The Spyder II 30 supports standard frames up to 25" x 36", while the larger Spyder II 52 supports frame sizes up to 54" x 46".

A full-featured Harlequin RIP is included to provide extremely fast and reliable file output. The Spyder II will also accept 1-bit tiff files from any other RIP so it will easily fit into an existing pre-press workflow.

Backing the system is EXILE's outstanding service and support. Whether onsite, over the phone or web, our technicians are sure to keep you printing smoothly and efficiently.

Features:

- Bi-Directional Printing
- Eliminates Film
- Reduced Labor Costs
- Precision Placement
- Faster Press Setup
- Improved Quality
- Reduced Exposure Times



5

FLASH CURING UNITS

PLUG N GO FLASH UNITS

Plug N Go flash units are specifically designed to work with our Freedom Express, Cutlass and Sabre lines of presses. The Sabre print arms are pre-wired to accept these flash units. The press will self-detect the flashes location.



FLASHBACK

Our patented Flashback when added to either the Freedom Express, Cutlass or Sabre presses creates the most versatile system in the industry. Print, flash and cool at any or all stations without losing a color.

Features:

- ▶ Adjustable shuttle-in/shuttle-out speeds
- ▶ Quick flashing quartz elements
- ▶ Quick-cooling turbo fans
- ▶ Heat reflector
- ▶ Adjustable height
- ▶ Easy to move from head to head



SFB-2020

(For use with all 6, 8, and 10 color machines. Sabre 12/14 not compatible.)

SUPER SECA FLASH CURING UNITS

The Super Seca is the most economical and functional flash curing unit in the industry. Keeping with the Workhorse tradition, the Super Seca is built to last with the dependability you rely on for your print shop's needs.

Features:

- ▶ 10 year warranty
- ▶ 360 degree head rotation
- ▶ Adjustable height
- ▶ Totally portable
- ▶ Infrared heat panel
- ▶ Energy reflectors for enhanced edge curing
- ▶ Sturdy 5 leg base
- ▶ 110V or 220V systems



SS16C

(Shown with optional SS-Auto-110V Auto Rotation Box and SS-Temp110V Temperature Control Box)

SUPER SECA FLASH OPTIONAL EQUIPMENT



AUTO ROTATION BOX

Selectable auto and manual modes, the auto rotation box moves your flash head to a safe home position between prints. Includes foot pedal control.

SS-Auto-110v
part 11010-SS-AUTO
110 Volt power

SS-Auto-220v
part 11010-SS-AUTO-220
220 Volt power



TEMPERATURE CONTROL BOX

This feature allows temperature reduction for scorch free flashing on all materials.

SS-Temp-110v
part 11010-SS-TEMP
110 Volt power

SS-Temp-220v
part 11010-SS-TEMP-220
220 Volt power



HEAVY DUTY CASTERS

Makes rolling the Super Seca from one work center to another easy.

SS-Caster
part 11010-SS-CASTERS
Set of 5

Model Number	FXP1618PGQF	SBR2024PGQF	SBR2024UNQF	XFB-1620	SFB2020
Part Number	XQF-1810/1820	SQF-2115/2110	SQF-2105/2100 Includes Photocell and Timer	XFB-1620	SFB-2020
Head Size	16" x 18" (41cm x 46cm)	20" x 24" (51cm x 61cm)	20" x 24" (51cm x 61cm)	16" x 20" (41cm x 46cm)	20" x 20" (51cm x 51cm)
Power Requirements	ELECTRIC 1-Phase, 220V, 55amps 3-Phase, 220V, 32amps	ELECTRIC 1-Phase, 220V, 60amps 3-Phase, 220V, 40amps	ELECTRIC 1-Phase, 220V, 60amps 3-Phase, 220V, 40amps	ELECTRIC 220V, 50-60Hz, 4400 Watts, 20 amps	ELECTRIC 220V, 50-60Hz, 4400 Watts, 20 amps

Model Number	SS1616C	SS1818C110	SS1818C220	SS1824C	SS2424C
Part Number	11010-SS-1616-C	11010-SS-1818-C	11010-SS-1818-220-C	11010-SS-1824-C	11010-SS-2424-C
Head Size	16" x 16" (41cm x 41cm)	18" x 18" (46cm x 46cm)	18" x 18" (46cm x 46cm)	18" x 24" (46cm x 61cm)	24" x 24" (61cm x 61cm)
Power Requirements	ELECTRIC 110V, 50-60Hz, 1600 Watts, 14 amps	ELECTRIC 110V, 50-60Hz, 1950 Watts, 17 amps	ELECTRIC 220V, 50-60Hz, 2500 Watts, 12 amps	ELECTRIC 220V, 50-60Hz, 3000 Watts, 14 amps	ELECTRIC 220V, 50-60Hz, 4000 Watts, 18 amps

SPECIALTY EQUIPMENT AND ACCESSORIES

N-SERIES NUMBER SYSTEM

We know space is valuable, that's one reason we developed the N-Series to be light and compact. The head assembly weighs in at just 18 pounds with screen. The universal fit makes the system compatible with any rear-mounted screen printing press; even your basic, entry-level, single-color, single-platen, table-top screen printing press.

Constructed of 1-3/4" aluminum tubing, the N-Series installation is no different than installing a standard screen printing screen.

If you know how to screen print, then you know how to install this numbering system.

Once the N-Series frame is loaded into your rear-mount press, changing or sliding your screen is easy. With a simple tilt and slide, snap in and out, adjusting and cleaning has never been so fast.

Check out all the N-Series packages for details on the N-1, N-2 and N-4 head assemblies.

The more heads you have on your carousel press, the quicker your jobs.

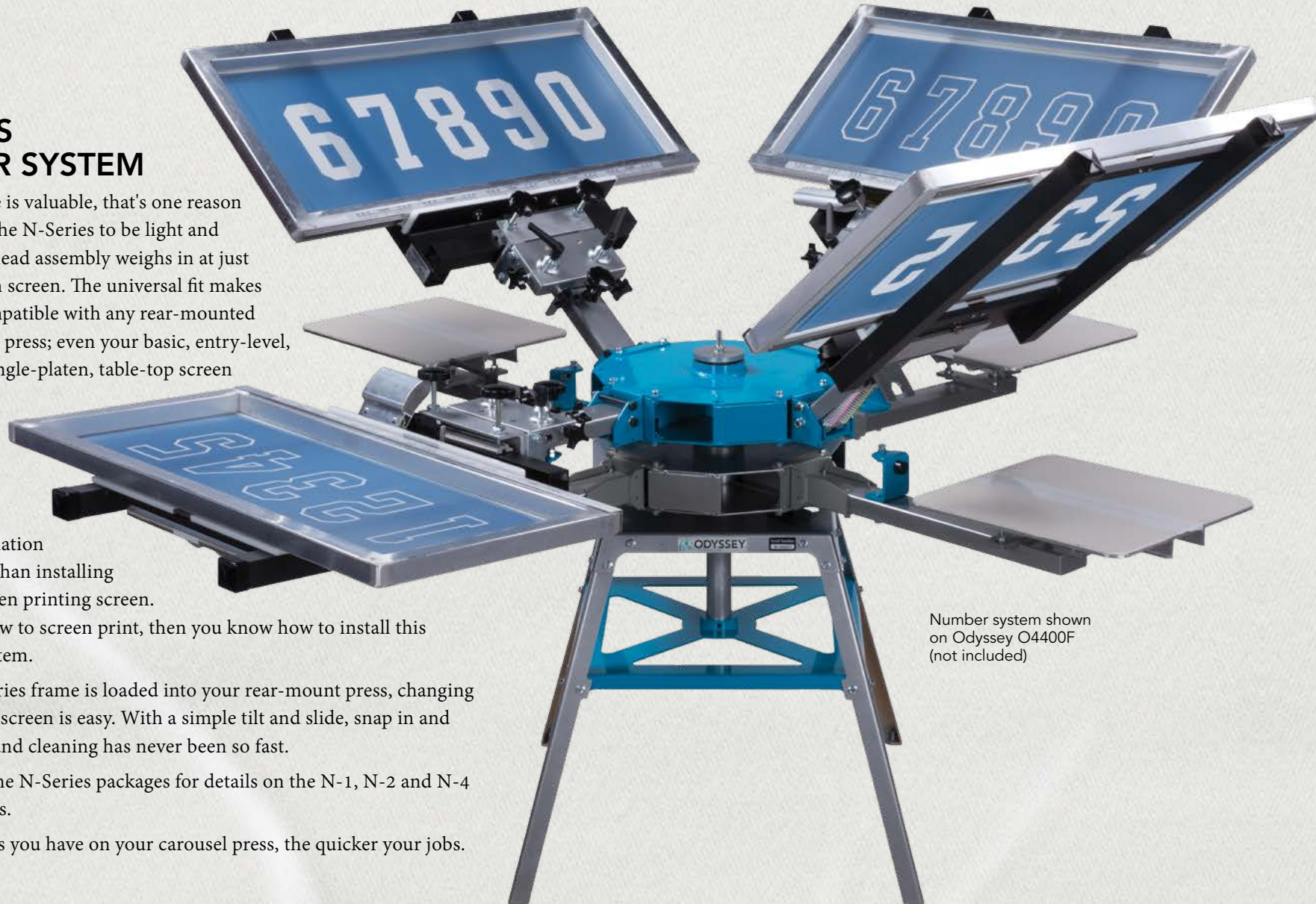

Number system shown on Odyssey O4400F (not included)



N-4 NUMBERING PACKAGE

Features:

- Four head numbering system
- Four numbering screens
- Four squeegees



N-1 NUMBERING PACKAGE

Features:

- Single head numbering system
- Four numbering screens
- Two squeegees

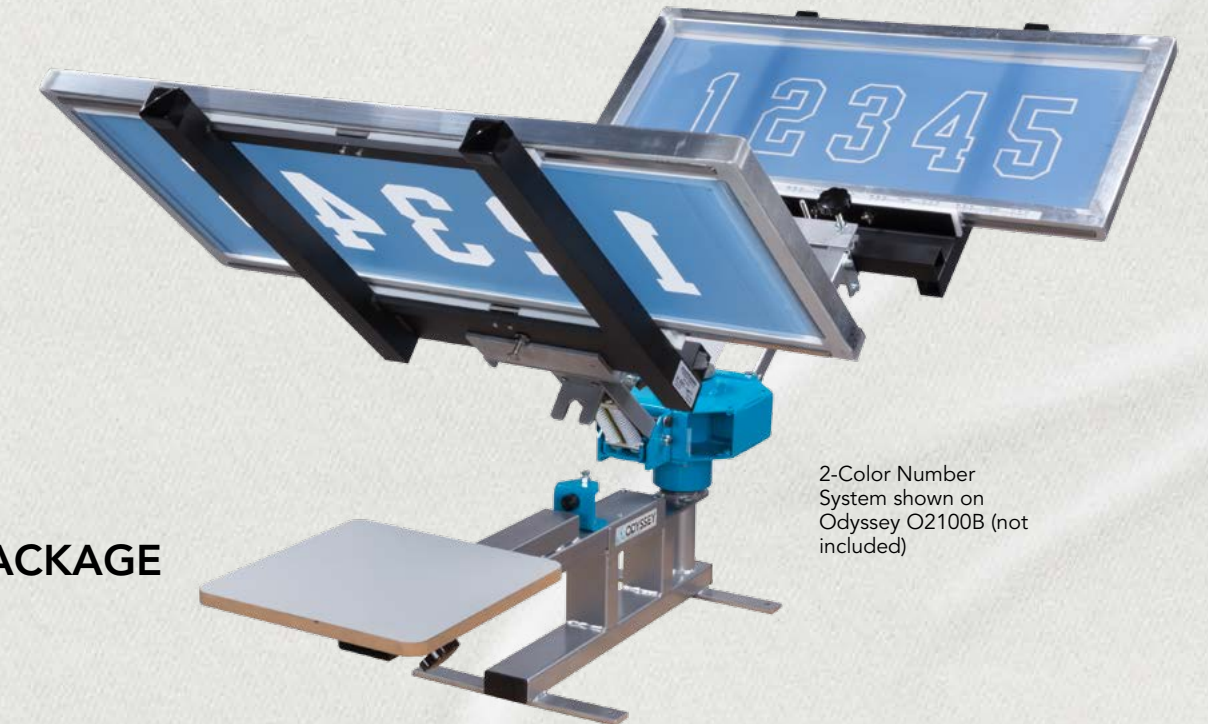

2-Color Number System shown on Odyssey O2100B (not included)

6

SPECIALTY EQUIPMENT AND ACCESSORIES

WORKHORSE SD-10 SERIES SCREEN DRYING CABINET

This unit is designed to eliminate problems associated with the screen preparation process. Problems such as dust and foreign materials caught in the emulsion, the application of block out and labor costs to repair pinholes and imperfections, and inconsistent drying times to name a few. The SD-10 will save you time, money and improve your overall screen quality. Its versatility to hold a variety of screen sizes, function as a perfect stand for most bench model exposure units and affordable price, make it a welcome addition to any print shop.

Features:

- ▶ 10-screen capacity from 20" x 24" up to 25" x 36"
- ▶ Digital temperature control
- ▶ Dual functioning exhaust



The SD-10 is the perfect size to allow the Lumitron MDLUM-LED 25" x 36" exposure unit to fit on top.

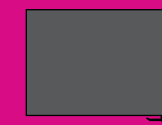

Model Number	SD-10
Part Number	SD-10
Max Screen Size	25" X 36" 63 cm x 91 cm
Power Requirements	115V, 60HZ, 22 AMPS
Dimensions (H x W x D)	35" X 43" X 35" 89 cm x 110 cm x 89 cm

GRIPPER

The Gripper is the answer for printing any two-ply garment where you must keep both the outer shell and inner lining from moving. It features a large 16" x 16" (41 x 41 cm) print area to accommodate full sized designs.

The unique design of the Gripper frame pulls the image area taught for printing. The lock-lever system can be adjusted to firmly hold any material thickness from running shorts to a quilted parka.



Model Number	GR-1616
Part Number	12512
Max Print Size	16" X 16" 41 cm x 41 cm
Dimensions (W x D)	16" X 16" 41 cm x 41 cm

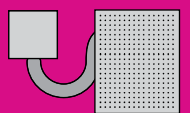

VACUPALLET

Make more money by printing heat transfers, bumper stickers, decals, signs and more. Simply depress the footswitch and the powerful vacuum motor holds flat stock securely without the use of spray adhesive.

Model Number	VP-1824
Part Number	12513
Depth x Width	18" X 24" 46 cm x 61 cm
Power Requirements	12V 110AC

6

SPECIALTY EQUIPMENT AND ACCESSORIES

WASH-IT

Available in two sizes, the Wash-It is ideal for developing and reclaiming your screens. Designed to work at waist height, these sinks are ergonomically built for function and comfort.

Features:

- ▶ Large screen capacity
- ▶ Multiple screen capacity
- ▶ Solid, waterproof steel construction
- ▶ Translucent back window
- ▶ Adjustable screen racks
- ▶ Easy and thorough drainage



WSH-36

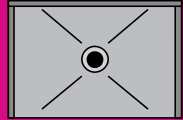
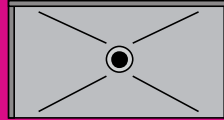

WSH-52

		
Model Number	WSH-36	WSH-52
Part Number	11506	11507
Dimensions (H x W x D)	72" X 36" X 24" 183 cm x 91 cm x 61 cm	72" X 52" X 24" 183 cm x 132 cm x 61 cm



ACCU-STRETCH

Printing at higher, uniform tensions provides faster production speeds, improved registrations, longer screen and squeegee life, more consistent ink deposits and lower ink usage. The patented Accu-Stretch provides these benefits while eliminating complicated stretching systems, training and expensive tools. Self-equalizing stretch clamps provide uniform tension while minimizing fabric waste by enabling you to stretch directly from the fabric bolt. The modular design enables Accu-Stretch to be expanded to virtually any size and width of fabric and frame materials. Choose from any one of nine Accu-Stretch systems and add any combination of five sizes of Accu-Stretch Modular Upgrades to create a stretching system for your exact needs.

Features:

- ▶ 9 sizes of complete Accu-Stretch systems
- ▶ 5 sizes of Accu-Stretch upgrades
- ▶ Adjustable down to 10" x 15" (24 x 38cm)
- ▶ Infinite independent warp and weft tension controls
- ▶ Brace-bar pre-bows frames
- ▶ Self-equalizing clamps for even tension
- ▶ Compatible with all stretch and glue frames
- ▶ Reliable pneumatic design
- ▶ Easy-loading stretch-clamps
- ▶ Gentle PVC coated locking bars
- ▶ Stretch directly from fabric bolt

Model Number	AS-2436	AS-2448	AS-2460	AS-3636
Part Number	CA-0101A	CA-0102A	CA-0103A	CA-0107A
Max Length x Max Width	24" X 36" 61 cm x 91 cm	24" X 48" 61 cm x 122 cm	24" X 60" 61 cm x 142 cm	36" X 36" 91 cm x 91 cm
Power Requirements	AIR 110 PSI (7.6 BAR) 1 CFM (28 L/M)	AIR 110 PSI (7.6 BAR) 1 CFM (28 L/M)	AIR 110 PSI (7.6 BAR) 1 CFM (28 L/M)	AIR 110 PSI (7.6 BAR) 1 CFM (28 L/M)

Model Number	AS-3648	AS-3660	AS-4848	AS-4860	AS-6060
Part Number	CA-0108A	CA-0109A	CA-0116A	CA-0117A	CA-0126A
Max Length x Max Width	36" X 48" 91 cm x 122 cm	36" X 60" 91 cm x 142 cm	48" X 48" 122 cm x 122 cm	48" X 60" 122 cm x 142 cm	60" X 60" 142 cm x 142 cm
Power Requirements	AIR 110 PSI (7.6 BAR) 1 CFM (28 L/M)	AIR 110 PSI (7.6 BAR) 1 CFM (28 L/M)	AIR 110 PSI (7.6 BAR) 1 CFM (28 L/M)	AIR 110 PSI (7.6 BAR) 1 CFM (28 L/M)	AIR 110 PSI (7.6 BAR) 1 CFM (28 L/M)

6 SPECIALTY EQUIPMENT AND ACCESSORIES



CPMX4

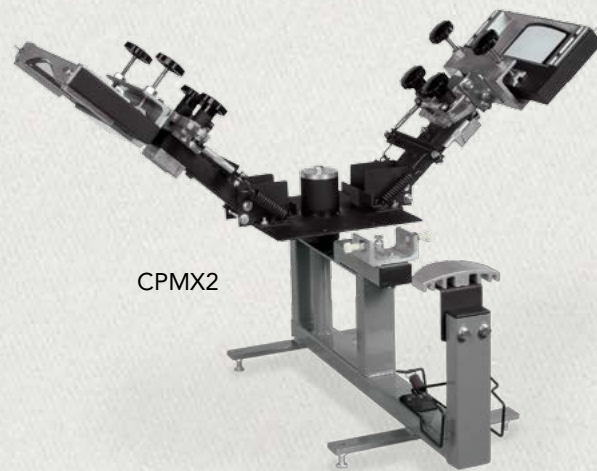

CPMX2



CPMX1

CAPMAX SCREENS

CapMax Screens come in a wide range of mesh counts. Choose lower mesh counts for simple, bold designs or for thicker ink deposits. Choose higher mesh counts for detailed designs, halftone designs or for thinner ink deposits.



CAPMAX PLATENS

A wide variety of quick change CapMax platens are available to provide the perfect fit for virtually every type and size of cap. CapMax printers come standard with a CP2 platen which fits twill, poplin, and nylon caps. In addition you can get CP1 for low crown youth caps, CP3 or CP4 for summer mesh caps, or CP5 for visors. CP6 has a groove machined in the center enabling you to print right over the seam on low crown, 6-panel caps.



	CPMX1	CPMX2	CPMX4
Model Number			
Part Number	10204	10203	10201
Colors/Stations	1 Color/1 Stations	2 Colors/1 Station	4 Colors/1 Station
Length x Width	30" X 12" 76 cm x 30 cm	40" X 12" 102 cm x 30 cm	40" X 40" 102 cm x 102 cm

7 SAMPLE SHOP PACKAGES

STARTER PACKAGE 3

Includes:
O4100B
Odyssey Manual Screen Press
LUMUV Lumitron UV
Fluorescent Exposure System
SS16C
Super Seca 16" x 16" Flash
CD-205
Odyssey Compact Dryer



Lumitron Fluorescent LUMUV



Odyssey O4100B



Super Seca SS16C



Odyssey Compact Dryer CD-205

PRO PACKAGE 3

Includes:
M-64-O
Mach Series
MDLUM-LED
Luminator LED Exposure Unit
WSH-36
36" Wash It
SS1818C
Super Seca 18" x 18"
PQ2608
Powerhouse Quartz Dryer



Mach Series M-64-O



Luminator MDLUM-LED



WSH-36



Super Seca SS1818C



Powerhouse Quartz Dryer PQ2608

STARTER PACKAGE 6

Includes:
O6400F
Odyssey Manual Screen Press
SMLUM-LED
Lumitron LED Exposure Unit
WSH36
36" Wash It
SD10
Screen Drying Cabinet
SS1616C
Super Seca 16" x 16" Flash
CD227
Odyssey Compact Conveyor Dryer



SMLUM-LED



Odyssey O6400F



WSH-36



SD-10



Super Seca Flash SS1616C



Odyssey Compact Dryer CD227

PRO PACKAGE 5

Includes:
M66M
Mach Series
SSAuto
Temperature Control Box
SSTmp
Auto Rotation Box
LGLUM-LED
Luminator LED Exposure Unit
WSH-52
52" Wash It
SD-10
Screen Drying Cabinet
SS1818C
Super Seca 18" x 18"
3009-3-1P
Powerhouse Series II Dryer

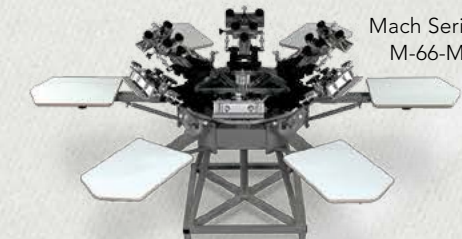

Mach Series M-66-M



LGLUM-LED



SSAuto



WSH-52



SD-10



Super Seca Flash SS1818C

3009-3-1P



WORKHORSE PRODUCTS

PRECISION SCREEN-PRINTING EQUIPMENT

3730 East Southern Ave., Phoenix, Arizona 85040
p. 800.778.8779 602.437.2305 workhorseproducts.com